

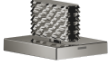





20 006 706

- with CASCADE structure
- hole diameter 32 mm
- rosette 60 x 47 mm
- with hot marking



	Dark Chrome	20 006 706-19
	Chrome	20 006 706-00
	Brushed Platinum	20 006 706-06
	Brushed Champagne (22kt Gold)	20 006 706-46
	Champagne (22kt Gold)	20 006 706-47
	Brushed Dark Platinum	20 006 706-99

20 006 706

mm [inches]

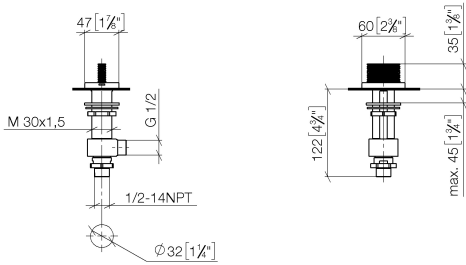

Flow rate chart



Certificates

IAPMO_N-4976. LGA_28687. IAPMO_6397. WRAS_240202020.

20 006 706

Parts for other finishes can be found here: [Chrome](#)

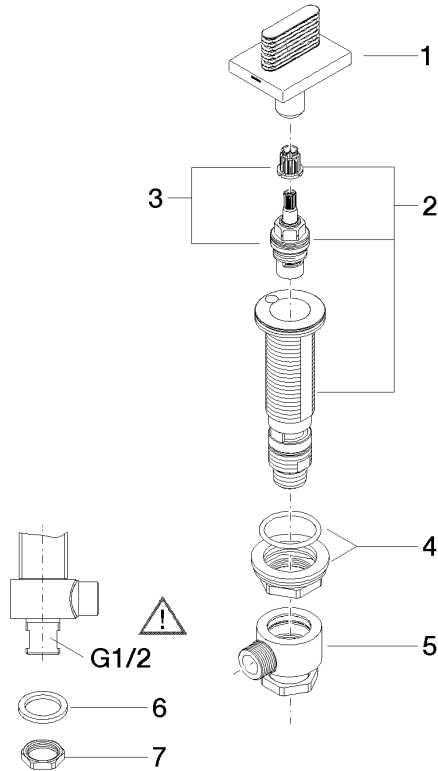

Spare parts list

No.	Item Number	Name	Quantity used	Delivery time
1	90 20 70 053 07-19	handle (hot)	1	20
2	04 17 11 058 52 90	side panel	1	2
3	90 90 03 152 00 90	top	1	2
4	04 23 10 032 78 90	fixing set	1	2
5	04 17 11 023 10 90	distributor	1	2
6	90 23 30 040 00-19	threaded connector	1	-
Spare part can no longer be ordered, please order the replacement item				
7	09 30 11 059 90	disc	1	2
8	09 23 10 012 90	nut	1	2